

Kevin Berni (B269580)
Ogden, UT



Vehicle History Report™

2018 TOYOTA HIGHLANDER XLE

VIN: 5TDJZRFH2JS842090
4 DOOR WAGON/SPORT UTILITY
3.5L V6 F DOHC 24V GASOLINE
ALL WHEEL DRIVE

Accident reported: minor to moderate damage

17 Service history records

2 Previous owners

Personal vehicle

103,191 Last reported odometer reading



This CARFAX Vehicle History Report is based only on information supplied to CARFAX and available as of 10/9/24 at 10:16:40 AM (CDT). Other information about this vehicle, including problems, may not have been reported to CARFAX. Use this report as one important tool, along with a vehicle inspection and test drive, to make a better decision about your next used car.



Accident / Damage History

Not all accidents / issues are reported to CARFAX

Event 1

04/03/2023

Accident reported: minor to moderate damage with another motor vehicle

- Airbags did not deploy

Damage Severity Scale

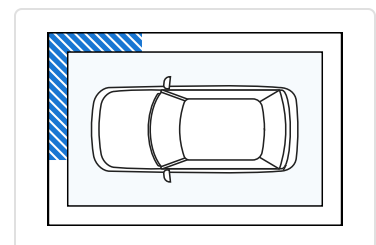

Additional History

Not all accidents / issues are reported to CARFAX

Total Loss
No total loss reported to CARFAX.



Owner 1

No Issues Reported

Owner 2

No Issues Reported

<p>Structural Damage CARFAX recommends that you have this vehicle inspected by a collision repair specialist.</p>	<p>✔ No Issues Reported</p>	<p>✔ No Issues Reported</p>
<p>Airbag Deployment No airbag deployment reported to CARFAX.</p>	<p>✔ No Issues Reported</p>	<p>✔ No Issues Reported</p>
<p>Odometer Check No indication of an odometer rollback.</p>	<p>✔ No Issues Indicated</p>	<p>✔ No Issues Indicated</p>
<p>Accident / Damage Accident reported: 04/03/2023.</p>	<p>✔ No Issues Reported</p>	<p>Accident Reported</p>
<p>Manufacturer Recall No open recalls reported to CARFAX. View Toyota disclosure</p>	<p>✔ No Recalls Reported</p>	<p>✔ No Recalls Reported</p>
<p>Basic Warranty Original warranty estimated to have expired.</p>	<p>Warranty Expired</p>	<p>Warranty Expired</p>

 Title History CARFAX guarantees the information in this section	Owner 1	Owner 2
<p>Damage Brands Salvage Junk Rebuilt Fire Flood Hail Lemon</p>	<p>✔ Guaranteed No Problem</p>	<p>✔ Guaranteed No Problem</p>
<p>Odometer Brands Not Actual Mileage Exceeds Mechanical Limits</p>	<p>✔ Guaranteed No Problem</p>	<p>✔ Guaranteed No Problem</p>
<p>  GUARANTEED - None of these title problems were reported by a U.S. state Department of Motor Vehicles (DMV). If you find that any of these title problems were reported by a DMV and not included in this report, you may qualify. View Terms </p>		



 Ownership History The number of owners is estimated	Owner 1	Owner 2
Year purchased	2018	2022
Type of owner	Personal	Personal
Estimated length of ownership	2 yrs. 10 mo.	2 yrs. 8 mo.
Owned in the following states/provinces	Georgia	Utah
Estimated miles driven per year	23,908/yr	13,819/yr
Last reported odometer reading	69,051	103,191















 Detailed History



Owner 1
Purchased: 2018

Personal Vehicle
23,908 mi/yr

Date	Mileage	Source	Comments
02/19/2018		NICB	Vehicle manufactured and shipped to Georgia
03/02/2018		Dealer Inventory	Vehicle offered for sale
10/06/2018		Georgia Motor Vehicle Dept.	Vehicle purchase reported - Titled or registered as personal vehicle
10/10/2018	62	Georgia Motor Vehicle Dept. Demorest, GA Title #770297182834965	Vehicle purchase reported - Title issued or updated - Title or registration issued - First owner reported - Loan or lien reported - Vehicle color noted as Black
07/29/2019		Georgia Motor Vehicle Dept. Demorest, GA Title #770297182834965	Registration issued or renewed - Loan or lien reported - Vehicle color noted as Black
08/09/2020		Georgia Motor Vehicle Dept. Demorest, GA Title #770297182834965	Registration issued or renewed - Loan or lien reported - Vehicle color noted as Black
05/21/2021	62,636	Xpress Lube & Car Wash Cleveland, GA 706-865-0144 ★ 4.8 / 5.0 131 Verified Reviews ❤️ 4 Customer Favorites	 Vehicle serviced - Maintenance inspection completed - Oil and filter changed
06/30/2021	66,432	Nininger's Tire and Auto Brunswick, MD 301-834-9855 ★ 5.0 / 5.0 60 Verified Reviews ❤️ 171 Customer Favorites	 Vehicle serviced - Tire repaired
07/27/2021	69,035	Jim Shorkey Cadillac Mazda Gainesville, GA 855-410-4016 ★ 4.5 / 5.0 140 Verified Reviews ❤️ 439 Customer Favorites	 Vehicle serviced - Maintenance inspection completed - Air filter replaced - Four wheel alignment performed - Vehicle washed/detailed - Oil and filter changed - Wiper(s) replaced

08/24/2021	C.A.R.Score Report	 Cosmetic inspection performed - Overall Score: 4.50 out of 5.0 - Interior: 4.40 out of 5.0 - Exterior: 4.50 out of 5.0 View condition report with images
08/25/2021	69,040 Auto Auction	Vehicle offered for sale - Vehicle sold  <div style="border: 1px solid blue; padding: 5px; margin-top: 10px;"> Millions of used vehicles are bought and sold at auction every year. </div>
09/14/2021	Ken Garff Ford Cheyenne Cheyenne, WY 800-447-3673  4.4 / 5.0 111 Verified Reviews  4 Customer Favorites 	 Vehicle serviced/reconditioned - Pre-delivery inspection completed - Fluids checked - Oil and filter changed - Tire condition and pressure checked <div style="border: 1px solid blue; padding: 5px; margin-top: 10px;"> Looks like this dealer serviced/reconditioned the car in order to prepare it for sale. That's a good thing! </div>
10/05/2021	69,048 Ken Garff Ford Cheyenne Cheyenne, WY 800-447-3673  4.4 / 5.0 111 Verified Reviews  4 Customer Favorites	 Vehicle serviced - Vehicle washed/detailed
11/16/2021	69,049 Ken Garff Ford Cheyenne Cheyenne, WY 800-447-3673  4.4 / 5.0 111 Verified Reviews  4 Customer Favorites	 Vehicle serviced - Engine/powertrain computer/module checked
12/02/2021	69,050 Ken Garff Honda Downtown Salt Lake City, UT  4.7 / 5.0 382 Verified Reviews  358 Customer Favorites	Vehicle offered for sale
12/03/2021	69,051 Ken Garff Honda Downtown Salt Lake City, UT	 Vehicle serviced - Drivability/performance checked - Emissions inspection performed

801-526-1700

★ 4.7 / 5.0

382 Verified Reviews

♥ 358 Customer Favorites



Looks like this dealer serviced the car in order to prepare it for sale. That's a good thing!

12/20/2021	Utah Motor Vehicle Dept.	Vehicle purchase reported
12/28/2021	Ken Garff Honda Downtown Salt Lake City, UT 801-526-1700 ★ 4.7 / 5.0 382 Verified Reviews ♥ 358 Customer Favorites	Vehicle serviced - Maintenance inspection completed

Owner 2
Purchased: 2022

Low mileage! This owner drove less than the industry average of 15,000 miles per year.

Personal Vehicle
13,819 mi/yr

Date	Mileage	Source	Comments
01/19/2022		Utah Motor Vehicle Dept. Ogden, UT	Registration issued or renewed - New owner reported - Loan or lien reported - Passed safety inspection - Vehicle color noted as Black
01/28/2022	70,819	Ken Garff Honda Downtown Salt Lake City, UT 801-526-1700 ★ 4.7 / 5.0 382 Verified Reviews ♥ 358 Customer Favorites	Vehicle serviced
02/17/2022		Utah Motor Vehicle Dept. Ogden, UT Title #E000918883UT	Title issued or updated - Loan or lien reported - Vehicle color noted as Black
06/23/2022	77,099	Ken Garff Honda Riverdale Ogden, UT 801-781-4700 ★ 4.7 / 5.0	Vehicle serviced - Maintenance inspection completed - Fluids checked - Oil and filter changed - Tires rotated - Body lubricated

269 Verified Reviews

♥ 221 Customer Favorites

07/12/2022 78,054

Ken Garff Nissan
Riverdale
Ogden, UT
801-781-4500



Vehicle serviced

- Maintenance inspection completed
- Battery/charging system checked
- Tire repaired

★ 4.6 / 5.0

281 Verified Reviews

♥ 195 Customer Favorites

12/20/2022 84,389

Ken Garff Honda
Riverdale
Ogden, UT
801-781-4700



Vehicle serviced

- Maintenance inspection completed
- Fluids checked
- Oil and filter changed
- Tires rotated
- Body lubricated

★ 4.7 / 5.0

269 Verified Reviews

♥ 221 Customer Favorites

01/02/2023

Utah
Inspection Station

Passed emissions inspection

01/02/2023

Utah
Motor Vehicle Dept.
Ogden, UT
Title #E000918883UT

Registration issued or renewed

- Loan or lien reported
- Passed safety inspection
- Vehicle color noted as Black

04/03/2023

Damage Report



Accident reported: minor to moderate damage with another motor vehicle

- Damage to right front
- Damage to front
- Airbags did not deploy

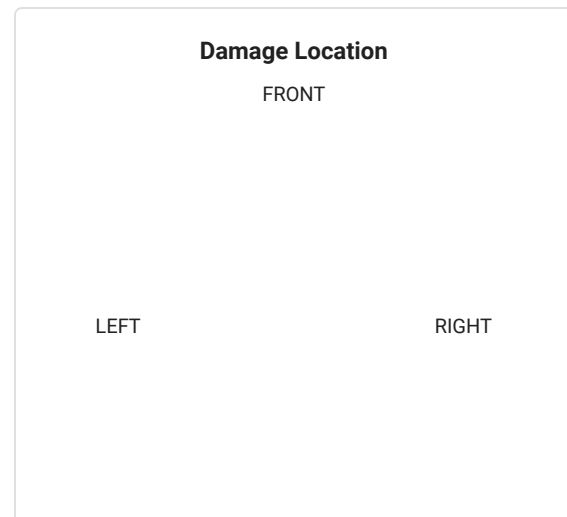
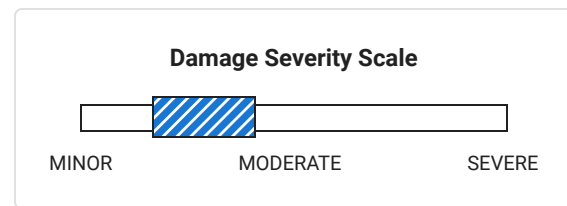

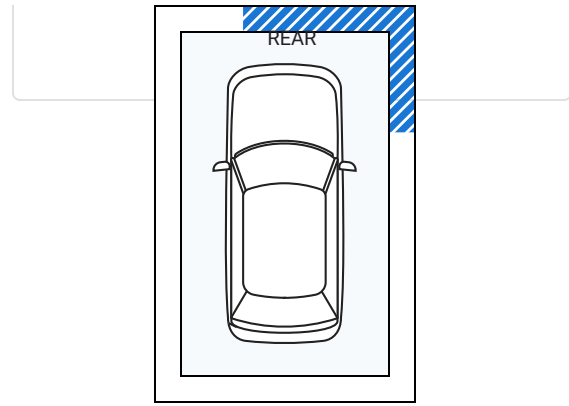

05/16/2023	87,977	M&B Repair Ogden, UT 801-645-7896		Vehicle serviced - Axles checked - Axle(s) replaced - Steering/suspension checked - Sway bar link(s) replaced - Four wheel alignment performed - Tire(s) balanced - Tire(s) mounted
		★ 4.6 / 5.0 13 Verified Reviews		
06/02/2023	88,519	Ken Garff Honda Riverdale Ogden, UT 801-781-4700		Vehicle serviced - Maintenance inspection completed - Fluids checked - Oil and filter changed - Tires rotated - Body lubricated
		★ 4.7 / 5.0 269 Verified Reviews ♥ 221 Customer Favorites		
07/07/2023	88,581	Shadetree Automotive Layton, UT 801-771-6711		Vehicle serviced
		★ 4.8 / 5.0 60 Verified Reviews ♥ 659 Customer Favorites		
10/20/2023	94,297	Ken Garff Honda Riverdale Ogden, UT 801-781-4700		Vehicle serviced - Maintenance inspection completed - Tires rotated - Oil and filter changed
		★ 4.7 / 5.0 269 Verified Reviews ♥ 221 Customer Favorites		
12/07/2023		Utah Motor Vehicle Dept.		Registration issued or renewed - Loan or lien reported

		Ogden, UT Title #E000918883UT		- Passed safety inspection - Vehicle color noted as Black
06/01/2024	103,191	Take 5 Oil Change Ogden, UT 719-661-2075 ★ 4.9 / 5.0 38 Verified Reviews ❤️ 2 Customer Favorites		Vehicle serviced - Wiper(s) replaced - Air filter replaced - Oil and filter changed
09/16/2024		Utah Motor Vehicle Dept. Ogden, UT Title #UT010879312		Title issued or updated - Duplicate title issued - Vehicle color noted as Black

Have Questions? Consumers, please visit our Help Center at www.carfax.com. Dealers or Subscribers, please visit our Help Center at www.carfaxonline.com.



Glossary

Accident Indicator

CARFAX receives information about accidents in all 50 states, the District of Columbia and Canada.

Not every accident is reported to CARFAX. As details about the accident become available, those additional details are added to the CARFAX Vehicle History Report. CARFAX recommends that you have this vehicle inspected by a qualified mechanic.

- According to the National Safety Council, Injury Facts, 2021 edition, 5% of the 276 million registered vehicles in the U.S. were involved in an accident in 2019. Over 77% of these were considered minor or moderate.
- This CARFAX Vehicle History Report is based only on information supplied to CARFAX and available as of 10/9/24 at 10:16:40 AM (CDT). Other information about this vehicle, including problems, may not have been reported to CARFAX. Use this report as one important tool, along with a vehicle inspection and test drive, to make a better decision about your next used car.

Damage Severity

Damage events result in one of the following severity levels:

- Minor: Generally, minor damage is cosmetic (including dents or scratches), may only require reconditioning, and typically does not compromise a vehicle's operation and/or safety.
- Moderate: Moderate damage may affect multiple components of the vehicle and may impair the vehicle's operation and/or safety.
- Severe: Severe damage usually affects multiple components of the vehicle and is likely to compromise the vehicle's operation and/or safety.

CARFAX recommends getting a pre-purchase inspection at a certified collision repair facility.

First Owner

When the first owner(s) obtains a title from a Department of Motor Vehicles as proof of ownership.

New Owner Reported

When a vehicle is sold to a new owner, the Title must be transferred to the new owner(s) at a Department of Motor Vehicles.

Ownership History

CARFAX defines an owner as an individual or business that possesses and uses a vehicle. Not all title transactions represent changes in ownership. To provide estimated number of owners, CARFAX proprietary technology analyzes all the events in a vehicle history. Estimated ownership is available for vehicles manufactured after 1991 and titled

solely in the US including Puerto Rico. Dealers sometimes opt to take ownership of a vehicle and are required to in the following states: Maine, Massachusetts, New Jersey, Ohio, Oklahoma, Pennsylvania and South Dakota. Please consider this as you review a vehicle's estimated ownership history.

Title Issued

A state issues a title to provide a vehicle owner with proof of ownership. Each title has a unique number. Each title or registration record on a CARFAX report does not necessarily indicate a change in ownership. In Canada, a registration and bill of sale are used as proof of ownership.

Toyota Recall / Service Campaign

Portions of this report have been included under license from Toyota Motor North America, Inc. ("TOYOTA"), License Agreement TMS1013 . This data applies only to vehicle marketed or originally sold in Mexico and the United States of America, including Guam, Saipan, American Samoa, Puerto Rico, the U.S. Virgin Islands and the other United States territories and protectorates with currently open safety or emissions recalls, or service campaigns. While TOYOTA provides data to Carfax Inc. on a regular basis, this report may not include very recent activity. For the manufacturer's most current information on recall/campaign activity for any Toyota, Lexus or Scion brand vehicle, you must go to <http://toyota.com/recall> or <http://lexus.com/recall>.

Follow Us:



[facebook.com/CARFAX](https://www.facebook.com/CARFAX)



[@CARFAXinc](https://twitter.com/CARFAXinc)



About CARFAX

CARFAX DEPENDS ON ITS SOURCES FOR THE ACCURACY AND RELIABILITY OF ITS INFORMATION. THEREFORE, NO RESPONSIBILITY IS ASSUMED BY CARFAX OR ITS AGENTS FOR ERRORS OR OMISSIONS IN THIS REPORT. CARFAX FURTHER EXPRESSLY DISCLAIMS ALL WARRANTIES, EXPRESS OR IMPLIED, INCLUDING ANY IMPLIED WARRANTIES OF MERCHANTABILITY OR FITNESS FOR A PARTICULAR PURPOSE.

© 2024 CARFAX, Inc., part of S&P Global. All rights reserved.
10/9/24 10:16:40 AM (CDT)